

# ***South Carolina***



**Work Zone Safety Guidelines  
for the South Carolina Department  
of Transportation, Municipalities,  
Counties, Utilities, and Contractors**

**— 2013 —**

## Table of Contents

<b>Introduction</b>	<b>2</b>
<b>Traffic Control Devices</b>	<b>2</b>
Signs	3-4
Channelizing Devices	5-7
Lighting Devices	7-8
<b>Five Parts of a Traffic Control Zone</b>	<b>9</b>
<b>Taper Length Criteria for Work Zones</b>	<b>10</b>
<b>Buffer Lengths</b>	<b>11</b>
<b>Duration of Work</b>	<b>11</b>
<b>Location of Work</b>	<b>12</b>
<b>Definitions</b>	<b>12-13</b>
<b>Typical Application Diagrams</b>	<b>13-14</b>
Shoulder Work (Beyond 15' From the Edge of Pavement)	15
Shoulder Work (1'-15' From the Edge of Pavement)	16
Shoulder Work with Minor Encroachment	17
Work in Center of a Minor Urban Street	18
Work in Travel Lane on a Minor Urban Street	19
Lane Closure on a Two-Lane, Low-Volume Road	20
Lane Closure on a Two-Lane Road, Daytime Only	21-22
Lane Closure on a Two-Lane Road, Nighttime	23-24
Temporary Road Closure	25
Center Turn Lane Closed on a Three-Lane, Two-Way Road	26
Lane Shift on a Three-Lane, Two-Way Road	27
Lane Closure on a Four-Lane Road	28
Lane Closure in Advance of an Intersection (Through Road)	29-30
Lane Closure in Advance of an Intersection (Side Road)	31-32
Lane Closure Beyond an Intersection (Through Road)	33-34
Lane Closure Beyond an Intersection (Side Road)	35-36
Closure in the Center of an Intersection	37
Lane Closure on a Freeway/Expressway	38
<b>Mobile Operations</b>	<b>38</b>
Mobile Operations on a Two-Lane Road	39-41
Mobile Operations on a Multi-Lane Road	42-45
<b>Pedestrian and Worker Safety</b>	<b>46-47</b>
Sidewalk Closure (Pedestrian Detour)	48
Sidewalk Diversion (Pedestrian Bypass Provided)	49
<b>Flagging Procedures</b>	<b>50</b>
<b>Liability</b>	<b>51</b>
<b>Supervisor's Checklist</b>	<b>51</b>
<b>Information</b>	<b>53</b>

## ***Introduction***

The purpose of this handbook is to present basic guidelines for work zone traffic control installation and maintenance. This handbook complies with the basic requirements of Part 6 of the Manual on Uniform Traffic Control Devices (MUTCD) and the South Carolina Department of Transportation (SCDOT) specifications with particular emphasis on short-term work sites on roads and streets in rural and small urban areas. This handbook is not intended for traffic control applications on interstate routes.

This handbook presents information and gives examples of typical traffic control applications for work zones on two-lane and multi-lane secondary and primary routes. This information is intended to illustrate the principles of proper work zone traffic control, but is NOT a standard. Part 6 of the MUTCD contains the national standards for work zone traffic control.

This handbook is NOT applicable to work performed under contract to the SCDOT. All work zones installed and maintained for SCDOT contract work shall comply with the typical traffic control standard drawings of the "Standard Drawings for Road Construction."

## ***Traffic Control Devices***

The following are four types of traffic control devices used in work zone traffic control:

- Signs
- Channelizing Devices
- Lighting Devices
- Pavement Markings

## Signs

Signs used in work zone traffic control are classified as regulatory, guide, or warning. Regulatory signs impose legal restrictions and may not be used unless authorized by the public agency having jurisdiction. Guide signs commonly show destinations, directions, and distances. Warning signs give notice of conditions that are potentially hazardous to traffic.

### Spacing of Advance Warning Signs

Sign Spacing (feet)						△		△		△		△
Urban ≤ 35 MPH	Urban 40-50 MPH	Rural 55 MPH	Expressway/ Freeway									
200	350	500	1,000	Y								Y
200	350	500	1,500	Y								Y
200	350	500	2,600	Y								Y

*Distances shown are approximate. Sign spacing should be adjusted for curves, hills, intersections, driveways, etc., to improve sign visibility.*

**Warning Signs** – Construction and maintenance warning signs are used extensively in street and highway work zones. These signs are normally diamond shaped, having a black symbol or message on an orange background. As a general rule these signs are located on the right-hand side of the street or highway.

**Size** – The standard size for advance warning signs in work zones is generally 48 inches by 48 inches. Where speeds and volumes are moderately low, a minimum size of 36 inches by 36 inches may be used (see Part 6 of the MUTCD for specific sign sizes.)

**Mounting** – Standards for height and lateral clearance of roadside signs are included in Part 6 of the MUTCD. Post-mounted signs shall be mounted at a height of at least 7 feet above the traveled way (measured from the bottom of the sign). Signs mounted on barricades

or other portable supports may be at lower heights, but the bottom of the sign shall be no less than one foot above the traveled way. Sign supports shall be crashworthy and in compliance with NCHRP Report 350 requirements.

**Illumination and Retroreflectorization** – All signs used during the hours of darkness shall be made of retroreflective material or illuminated. (Street or highway lighting is not regarded as meeting the requirements for sign illumination.) Reflectorize all orange advance warning construction signs and any orange areas of a multi-colored advance sign with a fluorescent orange colored prismatic reflective sheeting.

**Removal** – When work is suspended for short periods, all signs that are no longer appropriate shall be removed or covered. All portable sign supports shall lie flat with the legs in the retracted position when not in use.

## Channelizing Devices

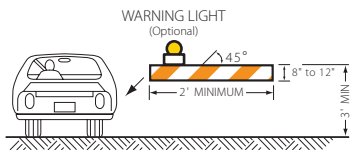

TYPE I BARRICADE

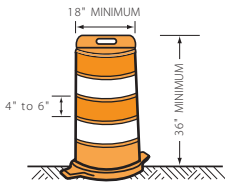

DRUM



TYPE II BARRICADE



TYPE III BARRICADE

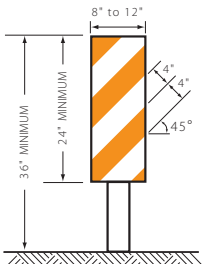

VERTICAL PANEL

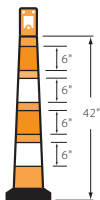
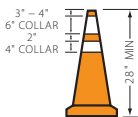
42" Oversized  
Lane Closures ONLY

Standard

CONES

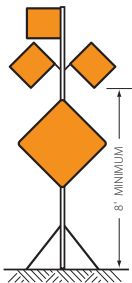
HIGH-LEVEL  
WARNING DEVICE  
(FLAG TREE)

### Notes:

1. Stripes on barricade rails slope downward at an angle of 45 degrees in the direction traffic is to pass.
2. Barricade rail stripe widths shall be 6 inches, except that 4-inch wide stripes may be used if rail lengths are less than 36 inches.
3. The sides of barricades facing traffic shall have retroreflective rail faces.
4. Stripes on 42" oversized cones shall be 6 inches, 2 orange and 2 white stripes, installed in an alternating pattern placing an orange stripe at the top.

## ***Channelizing Devices***

Channelizing devices are used to warn and alert drivers of hazards in work zones, protect workers, and guide and direct drivers and pedestrians past the hazards. Channelizing devices include cones, vertical panels, drums and barricades. The most common channelizing device used in temporary work zones is the traffic cone.

**Traffic Cones** – Traffic cones shall be orange in color and a minimum of 28 inches in height. Traffic cones used at night shall be retroreflectorized as shown on the previous page.

**Spacing** – Channelizing devices should be spaced so that it is apparent that the roadway or work area is closed to traffic. There are several rules of thumb that can be used to guide you in the proper spacing of channelizing devices.

1. The maximum spacing between devices in a taper should not exceed a distance, in feet, equal to the speed limit in MPH. For example if the taper is on a street with a 35 MPH speed limit, the devices may be spaced up to 35 feet.
2. All tapers should be made up of at least 6 channelizing devices.
3. The spacing between devices in a buffer or work area should not exceed a distance, in feet, of 2 times the speed limit in MPH; however, the spacing should not exceed 100 feet. For example, if the street has a speed limit of 35 MPH, the devices in the buffer and work area may be spaced up to 70 feet.
4. In urban areas shorter spacing between devices in the buffer and work areas may be more appropriate. For example the spacing used in tapers could also be used in buffers and work areas.

### Number of Channelizing Devices Needed

Length (feet)	35 MPH		45 MPH		55 MPH	
	Taper	Buffer/ Work	Taper	Buffer/ Work	Taper	Buffer/ Work
100	6	2-3	6	2-3	6	2-3
150	6	3-5	6	2-4	6	2-3
200	7	3-6	6	3-5	6	2-4
250	9	4-8	7	3-6	6	3-5
300	10	5-9	8	4-7	7	3-6
350	11	5-10	9	4-8	8	4-7
400	13	6-12	10	5-9	9	4-8
450	14	7-13	11	5-10	10	5-9
500	16	8-15	13	6-12	11	5-10
550	17	8-16	14	7-13	11	5-10
600	19	9-18	15	7-14	12	6-11
650	20	10-19	16	8-15	13	6-12

## Lighting Devices

Lighting devices for short-term work zones are designed to supplement the signs and channelizing devices used in these zones. Typical lighting devices include warning lights, vehicle rotating or strobe lights, and arrow panels.

**Warning Lights** – the principle types and use of warning lights are:

1. **Low-Intensity Flashing Lights (Type A)** – used at night to warn of an isolated hazard.
2. **High-Intensity Flashing Lights (Type B)** – used both day and night to warn of an isolated hazard or draw attention to advance warning signs.
3. **Low-Intensity Steady-Burn Lights (Type C)** – used at night in a series to delineate the edge of the travelway and channel traffic.

All warning lights, including Types A, B, and C, must be lightweight and may not exceed 3.3 pounds in accordance with the requirements of NCHRP Report 350.



### Arrow Panels

Panel Type	Roadway Speed	Min. Size	Min. # Lamps	Min. Legibility Distance
A	≤ 35 MPH	48" x 24"	12	½ Mile
B	40-50 MPH	60" x 30"	13	¾ Mile
C	≥ 55 MPH	96" x 48"	15	1 Mile

*For mobile operations on high-speed roadways Type B (60" x 30") Arrow Panels may be used.*

## Five Parts of a Traffic Control Zone

The traffic control zone is the area between the first advance warning sign and the point beyond the work space where traffic is no longer affected. Below is a diagram showing the five parts of a traffic control zone.

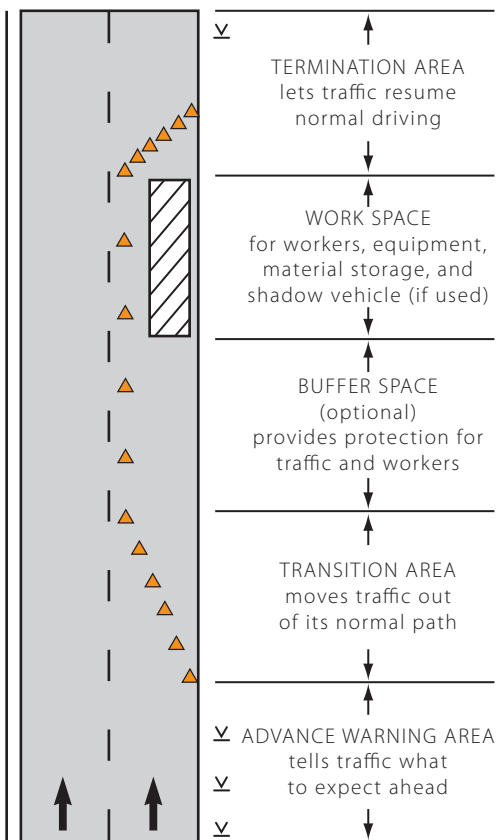

## Taper Length Criteria for Work Zones

There are five types of tapers used in work zone traffic control. The following are their lengths.

<u>Type of Taper</u>	<u>Taper Length</u>
Merging Taper	L Minimum
Shifting Taper	$\frac{1}{2}$ L Minimum
Shoulder Taper	$\frac{1}{3}$ L Minimum
One-Lane, Two-Way Traffic Taper	50 feet Minimum to 100 feet Maximum
Downstream Taper ( <i>use is optional</i> )	50 feet Minimum to 100 feet Maximum

### Formula for L

<u>Speed Limit</u>	<u>Formula</u>
40 MPH or Less	$L = \frac{WS^2}{60}$
45 MPH or Greater	$L = WS$

---

L = Taper length in feet

W = Width of offset in feet

S = Posted speed limit or off-peak 85th-percentile speed prior to work starting in MPH

## Buffer Lengths

The buffer area is an optional part of the work zone. It serves to separate traffic flow from the work area or a potentially hazardous area and might provide recovery space for an errant vehicle. Neither work activity nor storage of equipment, vehicles or materials should occur in this area.

### Guidelines for Buffer Lengths

Speed (MPH)	Length (feet)	Speed (MPH)	Length (feet)
20	115	50	425
25	155	55	495
30	200	60	570
35	250	65	645
40	305	70	730
45	360	75	820

A lateral buffer space may also be used to separate passing traffic from the work area. Its use and width are based on conditions at the work site.

## Duration of Work

Work duration is a major factor in determining the number and types of devices used in temporary traffic control zones. As a general rule, the longer the operation will last, more traffic control devices will be needed.

**Long-Term Stationary** – Work that occupies a location more than 3 days.

**Intermediate-Term Stationary** – Work that occupies a location from 12 hours to 3 days.

**Short-Term Stationary** – Daytime work that occupies a location from 1 to 12 hours.

**Short Duration** – Work that occupies a location up to 1 hour.

**Mobile** – Work that moves continuously.

## ***Location of Work***

The choice of traffic control needed for a temporary traffic control zone depends upon where the work is located. As a general rule, the closer the work is to traffic, the more traffic control devices will be needed.

## ***Definitions***

The following are several important definitions for terms used in these guidelines. These definitions were developed to aid the supervisor at the job site in determining the appropriate traffic control for the existing street or highway conditions. If the traffic conditions change during the course of the work, then the traffic control may need to change also.

**Low Speed** – Consider a low speed road to have a posted speed limit of 35 MPH or less.

**Intermediate Speed** – Consider an intermediate speed road to have a posted speed limit of 40 to 50 MPH.

**High Speed** – Consider a high speed road to have a posted speed limit of 55 MPH or greater.

**Low Volume** – As a general rule, a low-volume road can be considered one on which the average daily traffic volume (ADT) does not exceed 400 vehicles per day. If the traffic volumes are not known, the following rule of thumb can be used.

**Rule of Thumb** – Count the number of vehicles that pass a single reference point over a 5 minute period. If not more than 3 vehicles pass the reference point in that period, then the road can be considered low volume.

Special attention should be given to local, nearby facilities, such as schools, manufacturing plants, etc., that cause special traffic generation. Consideration should also be given as to whether the work zone location is subject to peak-hour traffic increases. Peak hours are usually 7-9 a.m. and 4-6 p.m., but will vary in different areas.

**Urban Street Conditions** – These streets are characterized by relatively low speeds, pedestrian activity, intersections, and frequent driveways for businesses and houses. While urban work zones will usually be on a city or town street, a work area does not have to be within a municipality's corporate limits in order to be considered an urban condition.

**Minor Urban Street** – A low-volume, low-speed, two-lane urban street.

## *Typical Application Diagrams*

The diagrams on the following pages represent examples of the application of principles and procedures for safe and efficient traffic control in work zones but are not intended to be standards. Part 6 of the MUTCD is the national standard for work zone traffic control. It is not possible to include illustrations to cover every situation which will require work area protection. These typical layouts are not intended as a substitute for engineering judgment and should be altered to fit the conditions of a particular site.

In addition to the typical diagrams, notes and tables are presented which provide important information for the user. **Read all notes before using these diagrams.** The information presented in these diagrams and tables are generally minimums for standard street and highway conditions. Also, it is the condition of the area that should be considered during application of these typicals. The work zone setup should be based upon anticipated vehicle speeds and rural versus urban conditions instead of posted speed limits or a municipality's corporate limits.

These typical diagrams are NOT intended for application to interstate routes. For further information, consult the SCDOT, Director of Traffic Engineering.

***Note: Taper lengths in these guidelines are based upon 12-foot lanes and 10-foot shoulders.***

## Legend



Channelizing Device



Flagger Symbol



Portable Sign Support



Arrow Panel



Work Vehicle with Rotating or Strobe Light

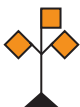

High Level Warning Device



Work Area



Warning Sign



Work or Shadow Vehicle with Truck-Mounted Attenuator (TMA)

## Shoulder Work

(Beyond 15' From the Edge of Pavement)

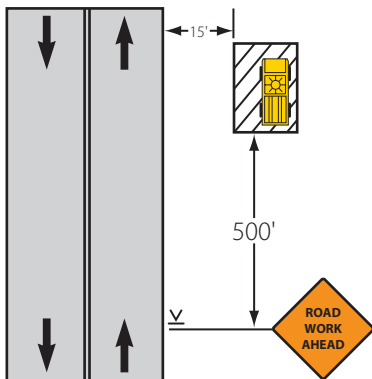

### Notes:

1. For low speed conditions (35 MPH or less), a 200-foot sign spacing may be used. For speeds of 40 to 50 MPH a 350-foot sign spacing may be used.
2. For operations of 60 minutes or less, all signs and channelizing devices may be eliminated **if the work vehicles are equipped with an activated amber rotating, flashing, or strobe light mounted on top of each vehicle in accordance with the following conditions:**  
**If the vehicle and work activity are both behind guardrail or beyond 15' but within 30' of the near edge of an adjacent travel lane.**  
 Vehicle hazard warning signals are not an acceptable alternative.
3. An advance warning sign is required at all times during the performance of work within 30' of the near edge of an adjacent travel lane, if the vehicles or equipment will intermittently access the work space from the roadway during the performance of the work, if equipment will travel on or cross the highway, or if the activity may distract motorists.
4. Acceptable advance warning signs are those indicating "Shoulder Work", "Road Work Ahead", or "Utility Work Ahead".



## Shoulder Work

(1' – 15' From the Edge of Pavement)  
(Short-Term Stationary — 1 to 2 Hours)

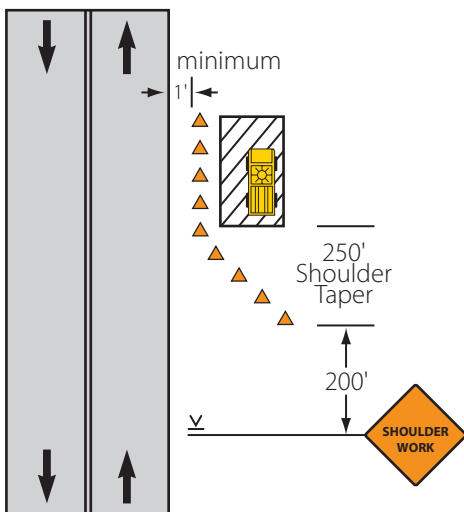

### **Notes:**

1. For intermediate speed conditions (40 to 50 MPH), a 350-foot sign spacing may be used, and for high speed conditions (55 to 60 MPH), use a 500-foot sign spacing.
2. For short-term stationary work zones in a shoulder area, an array of advance warning signs is required. Install these advance warning sign arrays as follows:
  - a. Low Speed Conditions (35 MPH or less) – this sign array will include “Shoulder Work”.
  - b. Intermediate Speed Conditions (40 to 50 MPH) – this sign array will include “Road Work Ahead”, “Right (Left) Shoulder Closed Ahead”, and “Shoulder Work”.
  - c. High Speed Conditions (55 to 60 MPH) – this sign array will include “Road Work 1500 FT”, “Right (Left) Shoulder Closed 1000 FT”, and “Right (Left) Shoulder Closed 500 FT”.
3. “Utility Work Ahead” or “Workers” symbol signs may be used instead of the “Shoulder Work” sign.

## Shoulder Work with Minor Encroachment

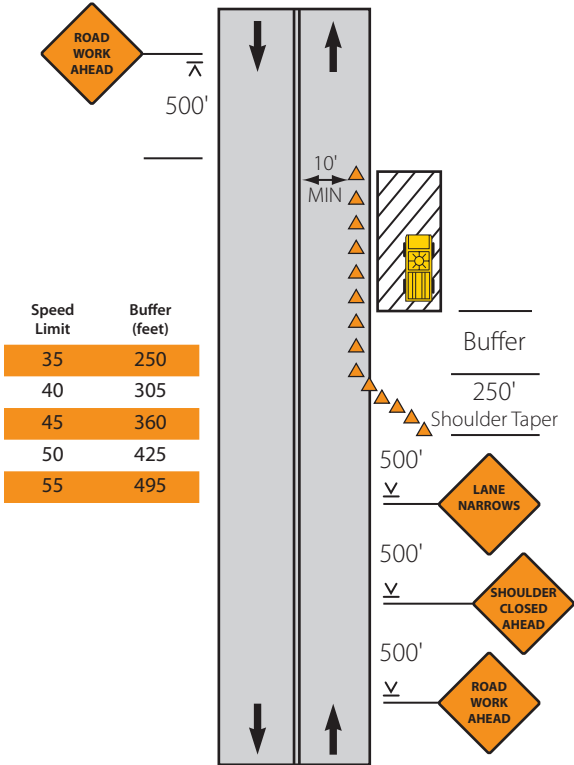

### Notes:

1. This typical application applies to roadways with posted speed limits of 55 MPH or less .
2. Maintain a minimum lane width of 10', however, on a low volume roadway, a minimum lane width of 9' is acceptable if traffic does not include wide loads.
3. For low speed conditions (35 MPH or less), a 200-foot sign spacing may be used and for intermediate speed conditions (40 to 50 MPH), a 350-foot sign spacing may be used.
4. An array of 3 advance warning signs is required. This sign array will include "Road Work Ahead", "Right (Left) Shoulder Closed Ahead", and "Lane Narrows".

## Work in Center of a Minor Urban Street (Maintaining Two-Way Traffic)

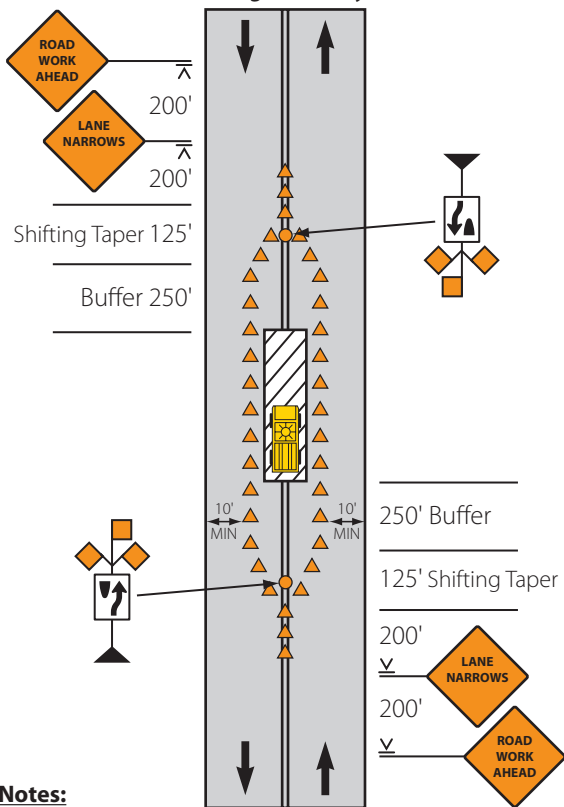

### Notes:

1. This typical application applies to low volume, low speed conditions (35 MPH or less) ONLY.
2. Maintain a minimum lane width of 10' in both directions. Measure from the near edge of the channelizing devices to the edge of pavement to determine the lane width.
3. Maintain the "Keep Right" symbol sign at the beginning of the taper as illustrated.
4. For low speed conditions (35 MPH or less), a 200-foot sign spacing may be used.
5. An array of 2 advance warning signs is required in each direction. These sign arrays will include "Road Work Ahead" and "Lane Narrows".

## Work in Travel Lane on a Minor Urban Street (Maintaining Two-Way Traffic)

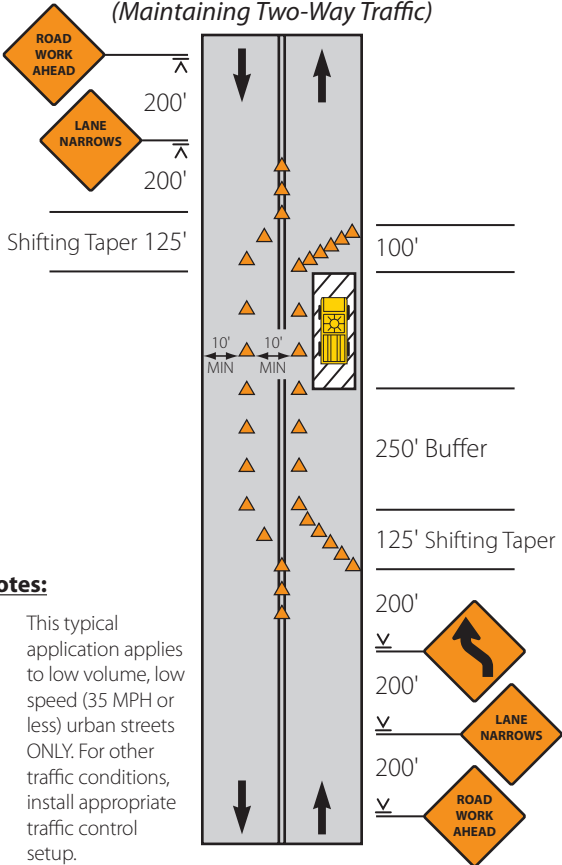

### Notes:

1. This typical application applies to low volume, low speed (35 MPH or less) urban streets ONLY. For other traffic conditions, install appropriate traffic control setup.
2. A minimum lane width of 10' is required in both directions, measured between the lines of channelizing devices and measured from the line of channelizing devices separating the opposing travel lanes to the edge of pavement.
3. For low speed conditions (35 MPH or less), a 200-foot sign spacing may be used.
4. In the travel lane of the work, an array of 3 advance warning signs is required. This sign array will include "Road Work Ahead", "Lane Narrows", and "Reverse Curve". In the opposing travel lane, an array of 2 advance warning signs is required. This sign array will include "Road Work Ahead" and "Lane Narrows".

## Lane Closure on a Two-Lane, Low-Volume Road (One-Flagger Operation)

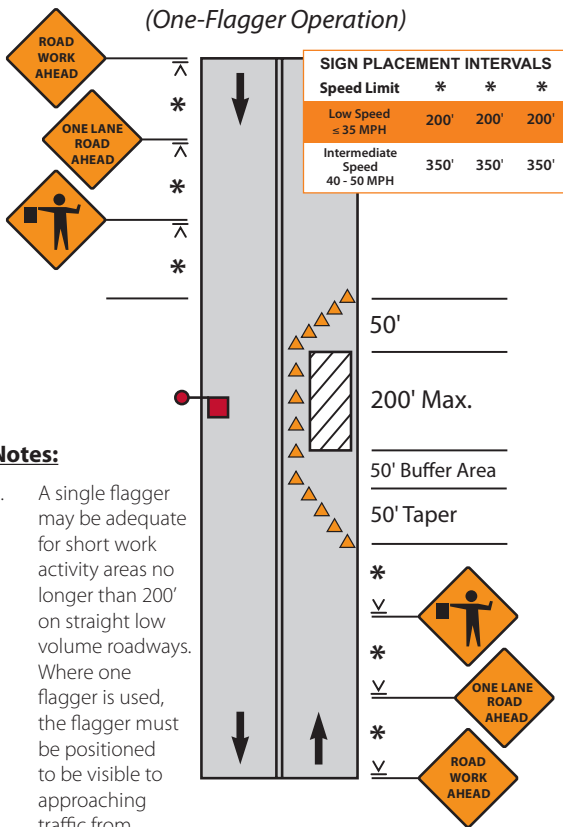

### Notes:

1. A single flagger may be adequate for short work activity areas no longer than 200' on straight low volume roadways. Where one flagger is used, the flagger must be positioned to be visible to approaching traffic from both directions. Standing on the shoulder directly opposite the work area, the flagger directs traffic with the STOP/SLOW paddle.
2. A single flagger operation is restricted to daytime hours ONLY.
3. For low speed (35 MPH or less) conditions, a 200-foot sign spacing may be used. For speeds of 40 to 50 MPH a 350-foot sign spacing may be used.
4. An array of 3 advance warning signs is required in each direction. This sign array will include "Road Work Ahead", "One Lane Road Ahead", and "Flagger" symbol.

## Lane Closure on a Two-Lane Road (Two-Flagger Operation – Daytime ONLY)

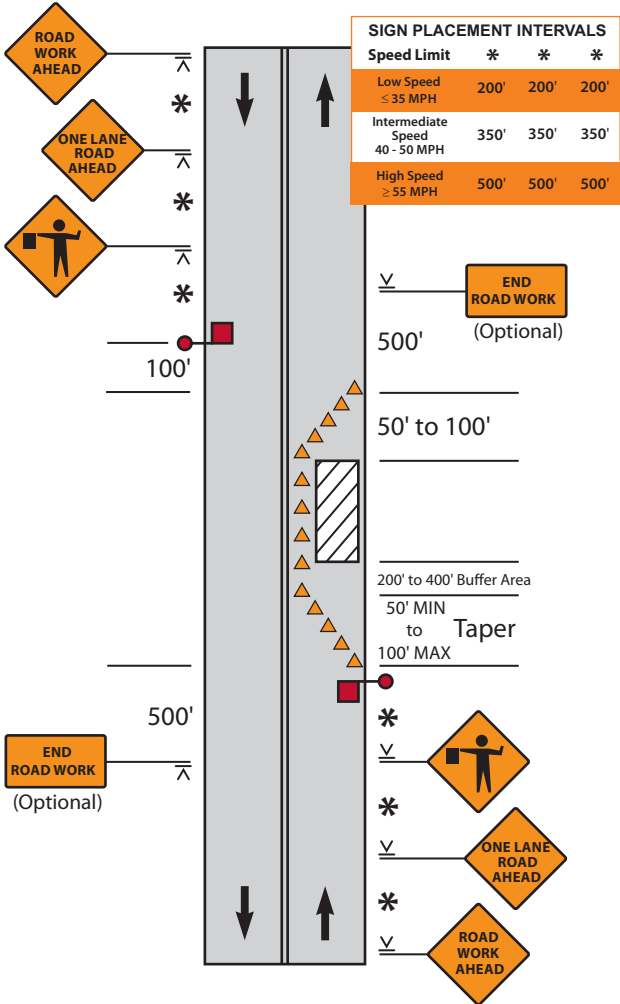

Notes: see page 22.

## ***Lane Closure on a Two-Lane Road*** ***(Two-Flagger Operation – Daytime ONLY)*** — Continued —

### **Notes:**

1. This typical application applies to flagging operations conducted during daytime hours ONLY.
2. For low-speed (35 MPH or less) conditions, a 200-foot sign spacing may be used. For speeds of 40 to 50 MPH a 350-foot sign spacing may be used.
3. An array of 3 advance warning signs is required in each direction. This sign array will include “Road Work Ahead”, “One Lane Road Ahead”, and “Flagger” symbol sign.
4. A “Be Prepared To Stop” sign may be added to the sign series, located between the “Flagger” symbol and the “One Lane Road Ahead” signs. If used, then the spacing of all four signs in the series will be spaced at equal intervals based on speed (see Note 2).
5. Generally, the use of “End Road Work” signs is optional for short duration work sites, operations of 60 minutes or less. However, if the work site itself is long, or the beginning and end of the work site are not visible to a driver passing through it, then “End Road Work” signs should be used.

## Lane Closure on a Two-Lane Road (Two-Flagger Operation – Nighttime)

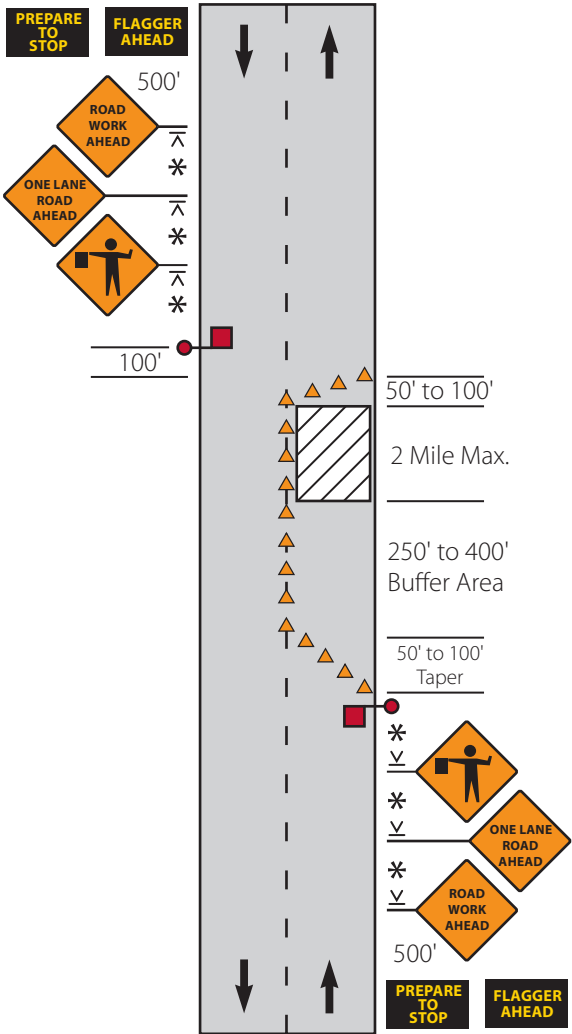

Notes and Sign Placement Intervals: see page 24.



## **Lane Closure on a Two-Lane Road** (Two-Flagger Operation – Nighttime) — Continued —

### **Sign Placement Intervals**

<b>Road Type</b>	<b>*</b>	<b>*</b>	<b>*</b>
<b>Low Speed Conditions (35 MPH or Less)</b>	200	200	200
<b>Intermediate Speed Conditions (40 - 50 MPH)</b>	350	350	350
<b>High Speed Conditions (55 - 60 MPH)</b>	500	500	500

### **Notes:**

1. This typical application applies to flagging operations conducted during nighttime hours. Nighttime flagging operations require a minimum of 2 flaggers.
2. An array of 3 advance warning signs and a trailer mounted changeable message sign is required in each direction. The complete sign array will include a trailer mounted changeable message sign, "Road Work Ahead", "One Lane Road Ahead", and "Flagger" symbol sign.
3. For low-speed (35 MPH or less) conditions, a 200-foot sign spacing may be used between the "Road Work Ahead", the "One Lane Road Ahead", and the "Flagger" symbol signs. For speeds of 40 to 50 MPH a 350-foot sign spacing may be used between the "Road Work Ahead", the "One Lane Road Ahead", and the "Flagger" symbol signs.
4. Install a changeable message sign 500 feet in advance of the advance warning sign array in each direction. The messages shall be "Flagger Ahead" and "Prepare To Stop".
5. Each flagger shall wear a safety vest and safety pants that comply with ANSI / ISEA 107 standard performance for Class 3 risk exposure, latest revision, and a hard hat. Only retroreflectorized safety vests and safety pants fabricated from fluorescent red-orange background material are acceptable.
6. Illuminate each flagger station with any combination of portable lights, standard electric lights, existing street lights, etc., that will provide a minimum illumination level of 108 Lx or 10 fc.

## Temporary Road Closure (Not to exceed 20 minutes)

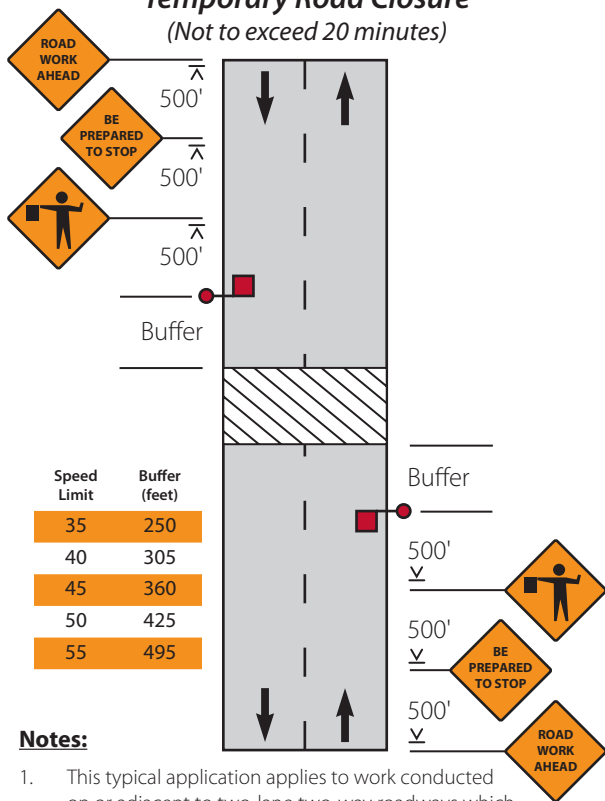

### Notes:

1. This typical application applies to work conducted on or adjacent to two-lane two-way roadways which requires temporary road closures.
2. This typical application applies to work operations conducted during daytime hours ONLY. For nighttime temporary closures, see notes 4, 5, and 6 on page 24.
3. This application is intended for a planned temporary road closure not to exceed 20 minutes.
4. For high-volume roads with intermediate or high speed conditions, assistance of law enforcement is required. Also, a changeable message sign may be added.
5. Maintain a 500-foot sign spacing for all temporary road closures.
6. Allow stopped traffic to proceed and clear the area after each temporary closure before stopping traffic again.

## Center Turn Lane Closed on a Three-Lane, Two-Way Road

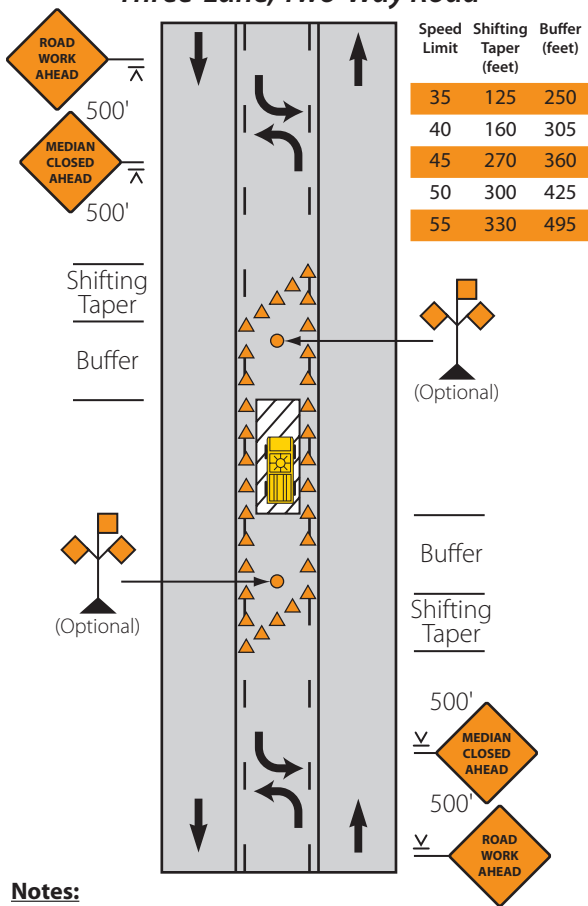

### Notes:

1. For low-speed (35 MPH or less) conditions, a 200-foot sign spacing may be used. For speeds of 40 to 50 MPH a 350-foot sign spacing may be used.
2. High-level warning devices (flag trees) may be used for added visibility.
3. An array of 2 advance warning signs is required. This sign array will include "Road Work Ahead" and "Median Closed Ahead" signs.

## Lane Shift on a Three-Lane, Two-Way Road

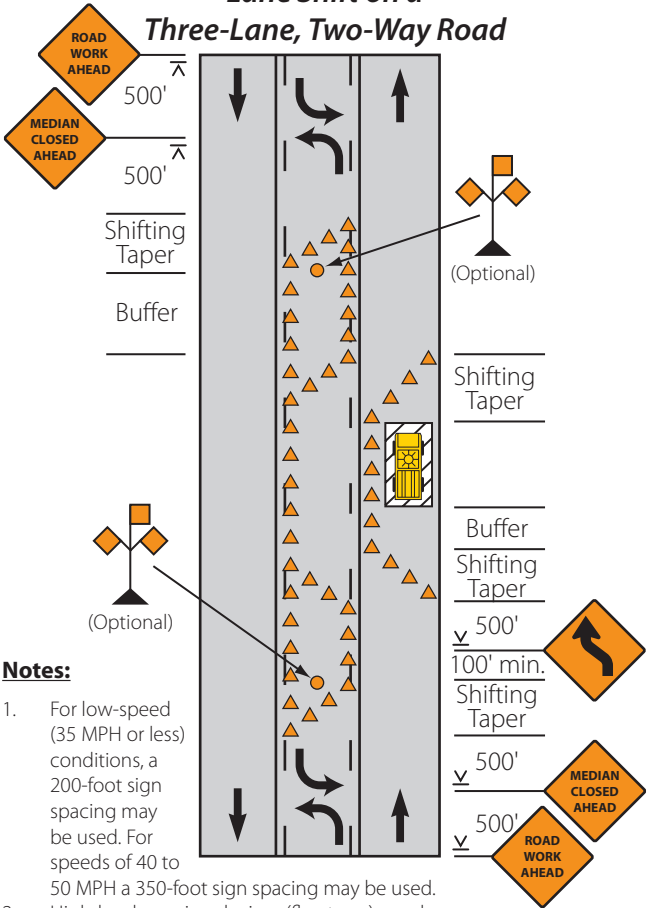

### Notes:

1. For low-speed (35 MPH or less) conditions, a 200-foot sign spacing may be used. For speeds of 40 to 50 MPH a 350-foot sign spacing may be used.
2. High-level warning devices (flag trees) may be used for added visibility.
3. In the travel lane of the work, an array of 3 advance warning signs is required. This sign array will include "Road Work Ahead", "Median Closed Ahead", and "Reverse Curve". In the opposing travel lane, an array of 2 advance warning signs is required. This sign array will include "Road Work Ahead" and "Median Closed Ahead" signs.

Speed Limit	Shifting Taper (feet)	Buffer (feet)
35	125	250
40	160	305
45	270	360
50	300	425
55	330	495

## Lane Closure on a Four-Lane Road

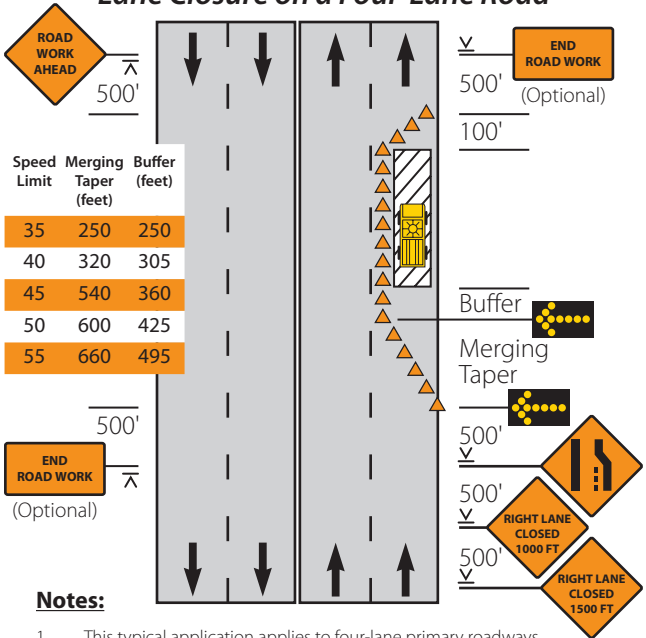

### Notes:

1. This typical application applies to four-lane primary roadways with speed limits of 60 MPH or less. This typical application is NOT applicable to interstate routes.
2. Maintain a 500-foot sign spacing for all lane closures on a four-lane roadway.
3. An array of 3 advance warning signs is required. This sign array will include "Right (Left) Lane Closed 1500 FT", "Right (Left) Lane Closed 1000 FT", and "Lane Ends" symbol sign.
4. When the left lane on an undivided road is closed, channelizing devices must be placed along the centerline as well. Closure of the opposing adjacent interior lane may also be considered in order to provide access to the work space, room for vehicles and materials, and a lateral buffer from the opposing traffic flow.
5. Approved advance warning arrow panels are required. Place the arrow panel on the shoulder of the roadway at the beginning of the merging taper. On roadways with high speed conditions, place a second arrow panel at the downstream end of the merging taper.
6. Supplement the shadow vehicle and the work vehicle with an approved advance warning arrow panel operating in the "Caution Mode" with the "Four Corners" display.
7. Generally, the use of "End Road Work" signs is optional for short duration work sites. However, if the work site itself is long or the beginning and end of the work site are not visible to a driver passing through it, the "End Road Work" signs should be used.



## ***Lane Closure in Advance of an Intersection*** ***(Work Area on the Through Road)*** — Continued —

### **Notes:**

1. For flagging operations conducted at night, see pages 23-24.
2. For low-speed (35 MPH or less) conditions, a 200-foot sign spacing may be used. For speeds of 40 to 50 MPH a 350-foot sign spacing may be used.
3. An array of 3 advance warning signs is required in each direction. This sign array will include "Road Work Ahead", "One Lane Road Ahead", and "Flagger" symbol sign.
4. A "Be Prepared To Stop" sign may be added to the sign series, located between the "Flagger" symbol and the "One Lane Road Ahead" signs. If used, then the spacing of all four signs in the series will be spaced at equal intervals based on speed (see Note 2).
5. Depending on traffic conditions, for low volume roadways additional traffic control, such as flaggers and appropriate advance signing may be needed on the side road approaches. For high volume roadways, additional flaggers and appropriate advance signing are required.

## Lane Closure in Advance of an Intersection (Work Area on the Side Road)

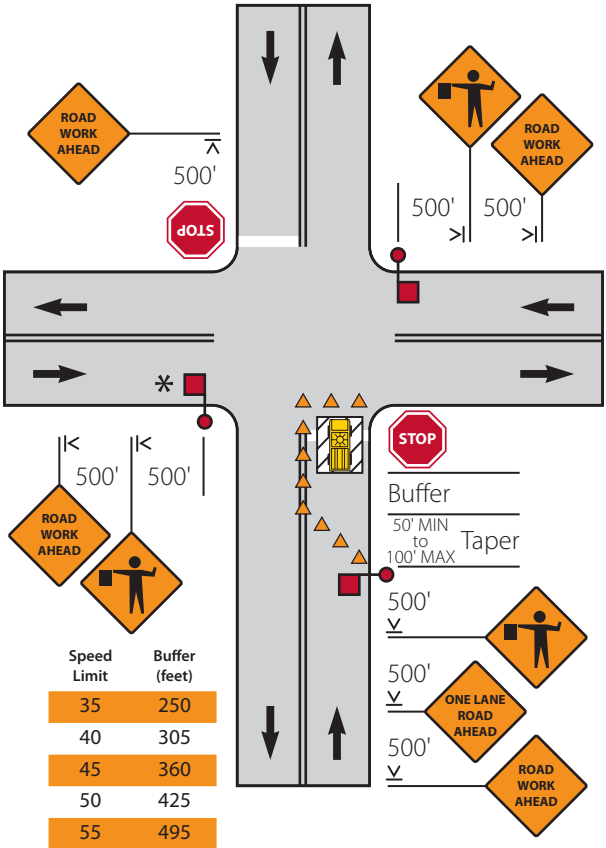

Notes: see page 32.



## ***Lane Closure in Advance of an Intersection*** ***(Work Area on the Side Road)*** — Continued —

### **Notes:**

1. For flagging operations conducted at night, see pages 23-24.
2. For low-speed (35 MPH or less) conditions, a 200-foot sign spacing may be used. For speeds of 40 to 50 MPH a 350-foot sign spacing may be used.
3. An array of 3 advance warning signs is required in each direction. This sign array will include "Road Work Ahead", "One Lane Road Ahead", and "Flagger" symbol sign.
4. A "Be Prepared To Stop" sign may be added to the sign series, located between the "Flagger" symbol and the "One Lane Road Ahead" signs. If used, then the spacing of all four signs in the series will be spaced at equal intervals based on speed (see Note 2).
5. Depending on traffic conditions, for low volume roadways additional traffic control, such as flaggers and appropriate advance signing may be needed on the mainline road approaches. For high volume roadways, additional flaggers and appropriate advance signing are required.
- \* 6. The middle flagger has the best view of traffic from all directions. This flagger should be designated lead flagger and should coordinate the actions of the other flaggers.

## Lane Closure Beyond an Intersection (Work Area on the Through Road)

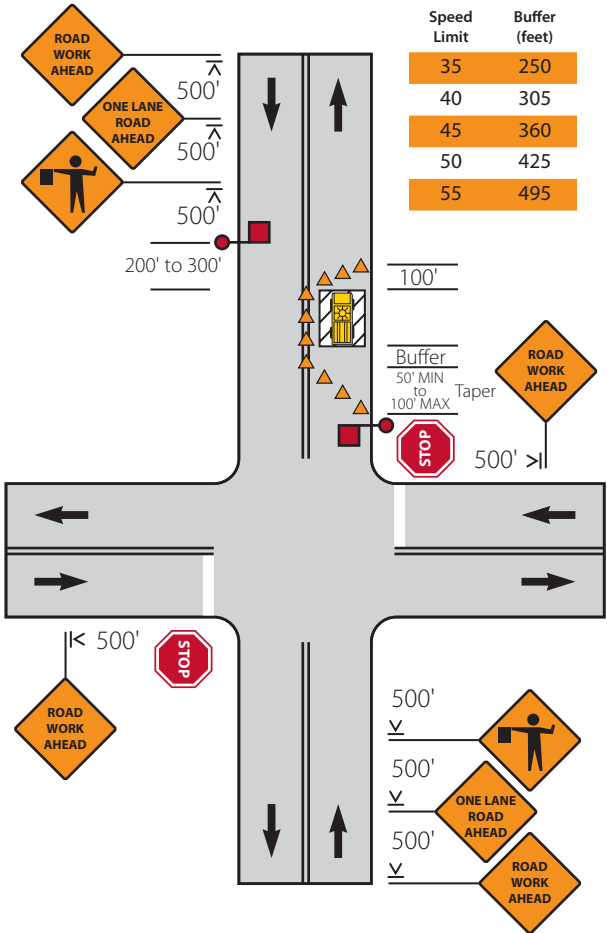

Notes: see page 34.

## ***Lane Closure Beyond an Intersection*** ***(Work Area on the Through Road)*** — Continued —

### **Notes:**

1. For flagging operations conducted at night, see pages 23-24.
2. For low-speed (35 MPH or less) conditions, a 200-foot sign spacing may be used. For speeds of 40 to 50 MPH a 350-foot sign spacing may be used.
3. An array of 3 advance warning signs is required in each direction. This sign array will include "Road Work Ahead", "One Lane Road Ahead", and "Flagger" symbol sign.
4. A "Be Prepared To Stop" sign may be added to the sign series, located between the "Flagger" symbol and the "One Lane Road Ahead" signs. If used, then the spacing of all four signs in the series will be spaced at equal intervals based on speed (see Note 2).
5. Generally, the use of "End Road Work" signs is optional for short duration work sites, operations of 60 minutes or less. However, if the work site itself is long, or the beginning and end of the work site are not visible to a driver passing through it, then "End Road Work" signs should be used.

## Lane Closure Beyond an Intersection (Work Area on the Side Road)

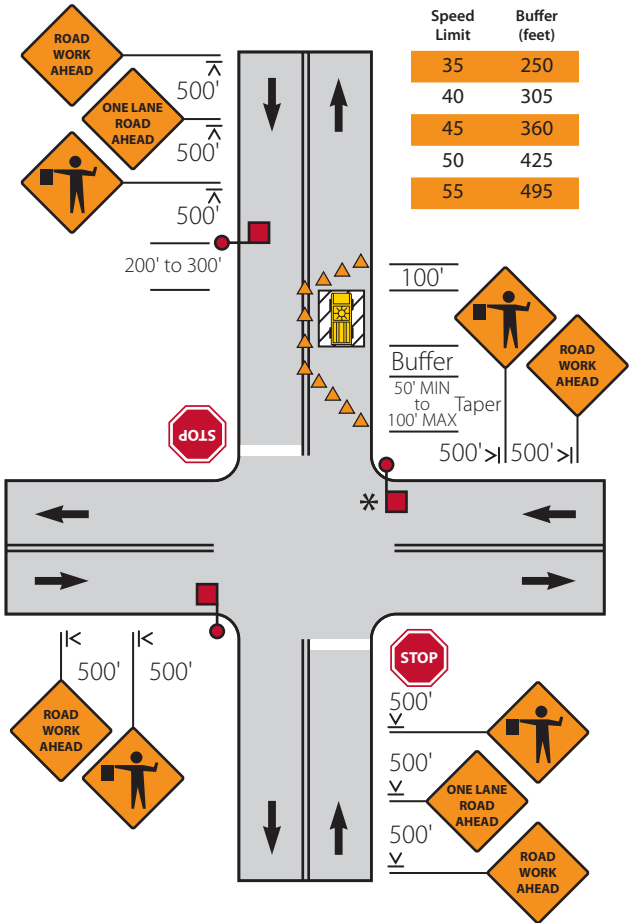

Notes: see page 36.

## ***Lane Closure Beyond an Intersection***

### ***(Work Area on the Side Road)***

— Continued —

#### **Notes:**

1. For flagging operations conducted at night, see pages 23-24.
2. For low-speed (35 MPH or less) conditions, a 200-foot sign spacing may be used. For speeds of 40 to 50 MPH a 350-foot sign spacing may be used.
- \* 3. The middle flagger has the best view of traffic from all directions. This flagger should be designated lead flagger and should coordinate the actions of the other flaggers.
4. Depending on traffic conditions, additional traffic control, such as flaggers and appropriate signing, may be needed.
5. An array of 3 advance warning signs is required in each direction. This sign array will include "Road Work Ahead", "One Lane Road Ahead", and "Flagger" symbol sign.
6. A "Be Prepared To Stop" sign may be added to the sign series, located between the "Flagger" symbol and the "One Lane Road Ahead" signs. If used, then the spacing of all four signs in the series will be spaced at equal intervals based on speed (see Note 2).
7. Generally, the use of "End Road Work" signs is optional for short duration work sites, operations of 60 minutes or less. However, if the work site itself is long, or the beginning and end of the work site are not visible to a driver passing through it, then "End Road Work" signs should be used.

## Closure in the Center of an Intersection

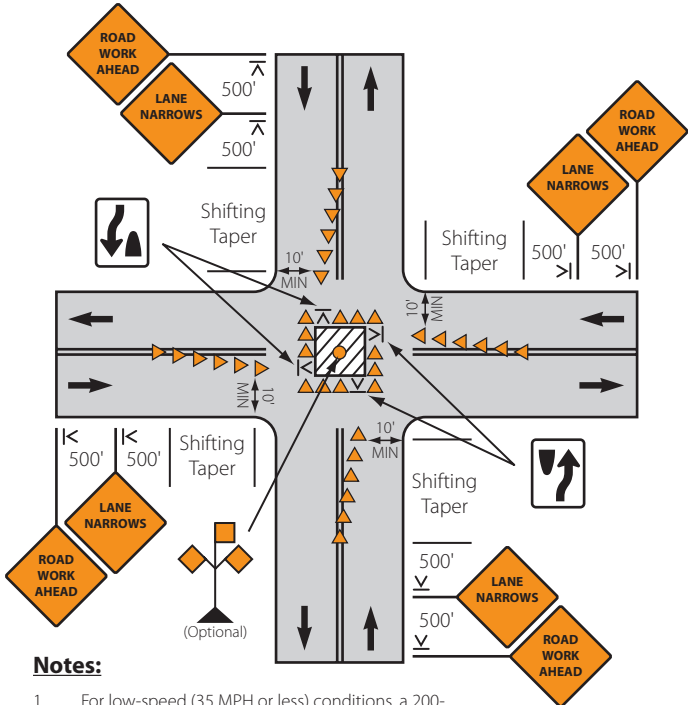

### Notes:

- For low-speed (35 MPH or less) conditions, a 200-foot sign spacing may be used. For speeds of 40 to 50 MPH a 350-foot sign spacing may be used.
- An array of 2 advance warning signs is required on each approach. This sign array will include "Road Work Ahead" and "Lane Narrows" signs.
- Maintain a minimum lane width of 10', measured to the near face of the nearest channelizing devices.
- Prohibit left turns as required by traffic conditions. Unless the streets are wide, it may be physically impossible to turn left, especially for large vehicles.
- A minimum of six channelizing devices shall be used for each taper.
- For operations of 60 minutes or less, the channelizing devices may be eliminated if a vehicle with an activated amber rotating, flashing, or strobe light mounted on top of the vehicle is used in the work space. Vehicle hazard warning signals are not an acceptable alternative.
- Install the "Keep Right" symbol signs within the tapers and at the points of closure.
- A high-level warning device (flag tree) may be used for added visibility.

Speed Limit	Shifting Taper (feet)
-------------	-----------------------

35	125
----	-----

40	160
----	-----

45	270
----	-----

50	300
----	-----

55	330
----	-----

## ***Lane Closure on a Freeway/Expressway***

### **Notes:**

1. For freeways and expressways, consult the South Carolina Department of Transportation.
2. All traffic control setups on a freeway or expressway such as the interstate system shall comply with the SCDOT "Standard Drawings for Road Construction."
3. All lane closures, shoulder closures, and mobile operations shall comply with all SCDOT hourly restrictions for these traffic control setups.

### ***Mobile Operations***

Mobile operations are work activities that move along the road continuously. Safety for mobile operations should not be compromised by using fewer devices simply because the operation will frequently change its location.

For mobile operations to be successful, the advance warning area for these operations must move with the work area or be repositioned periodically to provide warning for the motorist.

Portable devices should be used. Appropriately marked vehicles with amber rotating, flashing, or strobe lights mounted on top of each vehicle, perhaps augmented with signs, arrow panels, or changeable message signs, may be used in place of stationary signs and channelizing devices. During continuously moving mobile operations within the roadway, shadow vehicles are required as directed by the MUTCD. Shadow vehicles should be considered for shoulder work activities when shoulder areas are inadequate for equipment to operate without encroaching on the adjacent travel lane.

**Intermittent Mobile Operations** – These mobile operations (such as litter cleanup, pothole patching, or utility operations) often involve frequent short stops, and are similar to stationary operations. With operations that move slowly (less than 3 MPH), it may be feasible to use stationary signing that is periodically retrieved and repositioned in the advance warning area. Flaggers may be used, but caution must be exercised so they are not exposed to unnecessary hazards. Shadow vehicles should be considered in areas with limited sight distance due to horizontal or vertical curvature of the roadway.

**Continuously Moving Mobile Operations** – These mobile operations include work activities in which workers and equipment move along the road without stopping (mowing, pavement striping, street sweeping, or herbicide spraying), usually at slow speeds. On low volume low speed roadways, a well-marked and well-signed vehicle may suffice. On all other roadways, shadow vehicles are required so that the advance warning area moves with the work area.

## Mobile Operations on a Two-Lane Road

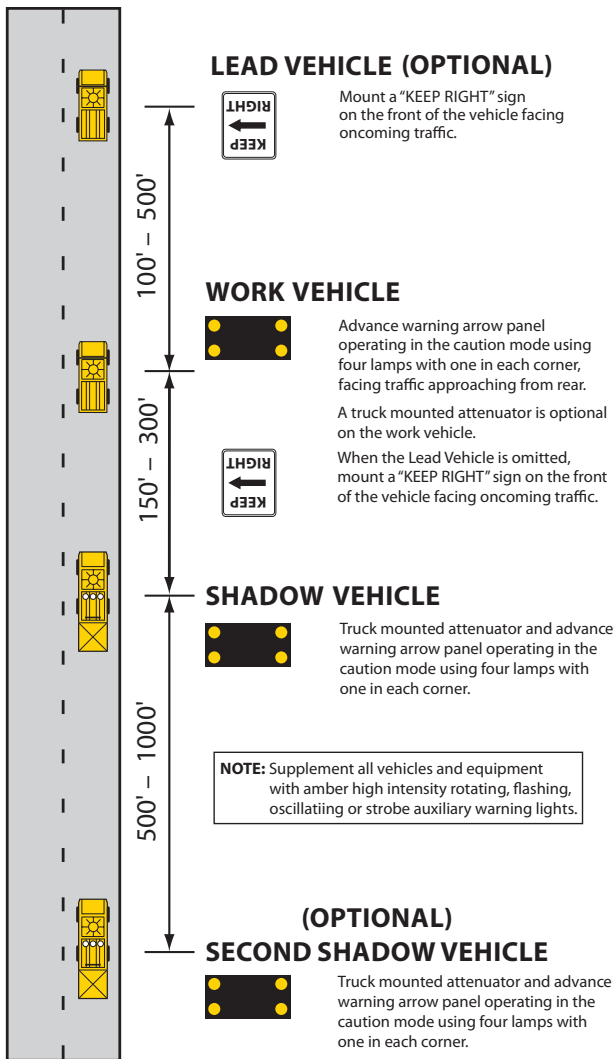

Notes: see pages 40-41.



## ***Mobile Operations on a Two-Lane Road***

— *Continued* —

### **Notes:**

1. The vehicle train for this mobile operation shall require a work vehicle and a shadow vehicle. A lead vehicle and a second shadow vehicle are optional but recommended on high volume roads with intermediate or high speed conditions.
2. Where variable distances are indicated on the typical application, adjust the distance intervals between the vehicles as necessary to compensate for the horizontal and vertical curves and any other conditions that may hinder or obstruct sight distance between the vehicles. Adjustments are restricted to the range of variable distances indicated in the illustration.
3. Maintain two-way radio communication between all vehicles in the mobile operation train.
4. Supplement all vehicles and equipment operating in this vehicle train with amber or yellow high intensity rotating, flashing, oscillating or strobe type auxiliary warning light devices. Standard vehicle hazard warning lights are only permitted as a supplement to the auxiliary warning lights.
5. Reflectorize all orange advance warning signs with approved fluorescent orange colored microprismatic retroreflective sheeting. Reflectorize all regulatory signs with approved white microprismatic retroreflective sheeting.
6. Supplement each shadow vehicle with an approved truck mounted attenuator (TMA) commensurate with the prevailing speeds of the traffic.
7. If the lead vehicle is used, it shall maintain a distance interval of 100 feet to 500 feet ahead of the work vehicle. The lead vehicle shall display a 24 inch x 30 inch "Keep Right" (R4-7a-24) sign mounted on the front of the vehicle facing oncoming traffic.
8. The work vehicle is required to have an approved advance warning arrow panel in the "Caution Mode" with the "Four Corners" display facing traffic approaching the work vehicle from the rear. Also, the work vehicle may be supplemented with an approved truck mounted attenuator (TMA).
9. If the lead vehicle is omitted, the work vehicle shall be supplemented with a 24 inch x 30 inch "Keep Right" (R4-7a-24) sign mounted on the front of the vehicle facing oncoming traffic.

**Additional notes on page 41.**

## ***Mobile Operations on a Two-Lane Road***

— *Continued* —

### **Notes:**

10. The primary shadow vehicle shall operate 150 feet to 300 feet behind the work vehicle and shall have an approved advance warning arrow panel operating in the “Caution Mode” with the “Four Corners” display mounted on the top of the vehicle and an approved truck mounted attenuator (TMA).
11. When utilized, the second shadow vehicle shall operate 500 feet to 1000 feet behind the primary shadow vehicle and shall have an approved advance warning arrow panel operating in the “Caution Mode” with the “Four Corners” display mounted on top of the vehicle and an approved truck mounted attenuator (TMA).

# Mobile Operations on a Multi-Lane Road

Multi-Lane Primary Route  
Earth Median with Earth or Paved Shoulders

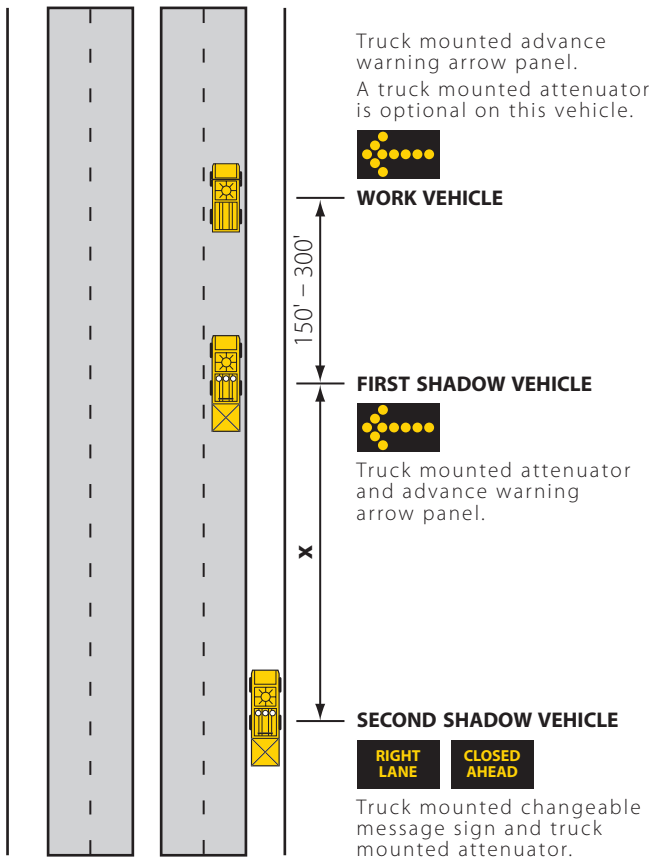

## Table for Variable Distance Intervals

X - The distance interval range between the first shadow vehicle and the second shadow vehicle

Speed Limit	X
45 MPH or Less	250' - 500'
50 MPH or Greater	500' - 1000'

Notes and additional diagram on pages 43-45.

## Mobile Operations on a Multi-Lane Road

— Continued —

Multi-Lane Primary Route  
Paved Median with Curb & Gutter

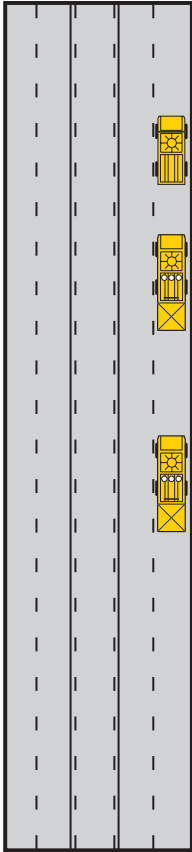

Truck mounted advance warning arrow panel.

A truck mounted attenuator is optional on this vehicle.



**WORK VEHICLE**

150' - 300'

**FIRST SHADOW VEHICLE**



Truck mounted attenuator and advance warning arrow panel.

X

**SECOND SHADOW VEHICLE**



The truck mounted changeable message sign will display the flashing arrow when the vehicle is operating in an active travel lane. The flashing arrow display is prohibited when the vehicle is operating on a shoulder.

Alternate Sign Display

**RIGHT LANE**

**CLOSED AHEAD**

Truck mounted changeable message sign and truck mounted attenuator. Display these messages when operating on a shoulder.

### Table for Variable Distance Intervals

X - The distance interval range between the first shadow vehicle and the second shadow vehicle

Speed Limit

X

45 MPH or Less

250' - 500'

50 MPH or Greater

500' - 1000'

Notes and additional diagram on pages 42 & 44-45.

## ***Mobile Operations on a Multi-Lane Road***

— *Continued* —

### **Notes:**

1. This typical application applies to mobile operations conducted on primary roadways with speed conditions ranging from low speed conditions (35 MPH or less) to high speed conditions (55 to 60 MPH).
2. The vehicle train for this mobile operation shall include the work vehicle and two shadow vehicles.
3. Where the ranges of variable distances are indicated on the typical application, adjust the distance intervals between the vehicles as necessary to compensate for the horizontal and vertical curves and any other conditions that may hinder or obstruct sight distance between the vehicles. Adjustments are restricted to the range of variable distances indicated in the illustration. The ranges of variable distances between the first shadow vehicle and the second vehicle are 250 feet to 500 feet for roadways with speed limits of 45 MPH or less and 500 feet to 1000 feet for roadways with speed limits of 50 MPH or greater.
4. Functional two-way radio communication is required between all vehicles in the mobile operation train.
5. Supplement each shadow vehicle with an approved truck-mounted attenuator (TMA) commensurate with the prevailing speeds of the traffic. A truck-mounted attenuator (TMA) is optional for the work vehicle.
6. Supplement the work vehicle and the first shadow vehicle with approved advance warning arrow panels.
7. Supplement the second shadow vehicle with a truck-mounted changeable message sign capable of displaying two message lines of seven 18 inch characters.
8. Reflectorize all orange advance warning signs with fluorescent orange colored prismatic retroreflective sheeting.
9. The first shadow vehicle shall operate 150 feet to 300 feet behind the work vehicle and shall have an approved advance warning arrow panel and an approved truck-mounted attenuator (TMA) commensurate with the prevailing speeds of the traffic.
10. The second shadow vehicle shall operate 250 feet to 1000 feet behind the first shadow vehicle based on the speed limit of the roadway and as illustrated on the typical application.

**Additional notes and diagrams on pages 42-43 & 45.**

## ***Mobile Operations on a Multi-Lane Road***

— *Continued* —

### **Notes:**

The second shadow vehicle shall have an approved truckmounted changeable message sign and an approved truckmounted attenuator (TMA) commensurate with the prevailing speeds of the traffic. The truck-mounted changeable message sign shall flash alternately to read "Right Lane", "Closed Ahead" or "Left Lane", "Closed Ahead" as necessary. Also, the second shadow vehicle shall operate on the adjacent shoulder where paved shoulders or earth shoulders wide enough to accommodate vehicles are present. However, the second shadow vehicle shall operate within the travel lane when the shoulders are too narrow to accommodate vehicles, the shoulders are structurally inadequate, or curb & gutter is present. The truck mounted changeable message sign may display a flashing arrow when the second shadow vehicle must operate in an active travel lane. The flashing arrow display on the truck mounted changeable message sign is only permitted when the second shadow vehicle operates in an active travel lane and is prohibited when the second shadow vehicle operates on the shoulder.

11. Work should normally be done during off-peak hours.

**Additional notes and diagrams on pages 42-44.**

## ***Pedestrian and Worker Safety***

### **Pedestrian Safety**

When pedestrian travel paths (sidewalks or footpaths) are closed or disrupted by a construction, maintenance, or utility operation, then pedestrian traffic control is needed. This includes the use of signs, channelizing devices, flags, suitable fencing, devices to make the path detectable and traversable by persons with disabilities, etc., to direct pedestrian movement through or around the work zone.

There are three major considerations in planning for pedestrian safety in work zones on streets and highways:

- Do not guide pedestrians into direct conflicts with work site vehicles, equipment, or operations.
- Do not guide pedestrians into direct conflicts with mainline traffic moving through or around the work zone.
- Provide pedestrians with a safe, convenient travel path that replicates as nearly as possible the most desirable characteristics of sidewalks or footpaths.

All pedestrians, including young, older and disabled, need protection from potential injury and a smooth, clearly defined travel path without abrupt changes in grade or terrain. Provide temporary facilities that are detectable and traversable by persons with disabilities and include accessibility features consistent with the features present in the existing or former pedestrian facility.

### **Worker Safety**

The safety of workers in a work site is just as important as the safety of the public traveling through the work zone. The best protection for both is good work zone traffic control.

All workers should be trained in how to work next to traffic in a way that minimizes their vulnerability. In addition, workers with specific traffic control responsibilities should be trained in traffic control techniques, device usage, and placement.

Workers exposed to traffic shall be attired in bright, highly visible clothing such as vests, shirts, or jackets. For daytime work, these garments shall be fabricated with a fluorescent red-orange or a fluorescent yellow-green background material.

**Work Safety Apparel** – All persons on foot or on or within work equipment whose duties place them on highway right-of-way and expose them to potential risks of moving roadway traffic or construction equipment shall wear highvisibility safety apparel meeting the requirements of ISEA “American National Safety Standard for High-Visibility Safety Apparel,” also referred to as ANSI / ISEA 107-2004, standard performance for Class 2 or 3 risk exposure or the latest revisions.

During nighttime flagging operations, flaggers shall wear properly retroreflectorized safety apparel in compliance with the requirements of ANSI / ISEA 107-2004 standard performance for Class 3 risk exposure or latest revisions and a hard hat. Performance Class 3 safety apparel includes but is not necessarily limited to safety vest / safety pants combination, coverall / jumpsuit, jacket / parka / rainwear, or short sleeved jacket.

To further improve worker safety, consider the use of shadow vehicles, temporary traffic barriers, police, and road closures.



## Sidewalk Closure (Pedestrian Detour)

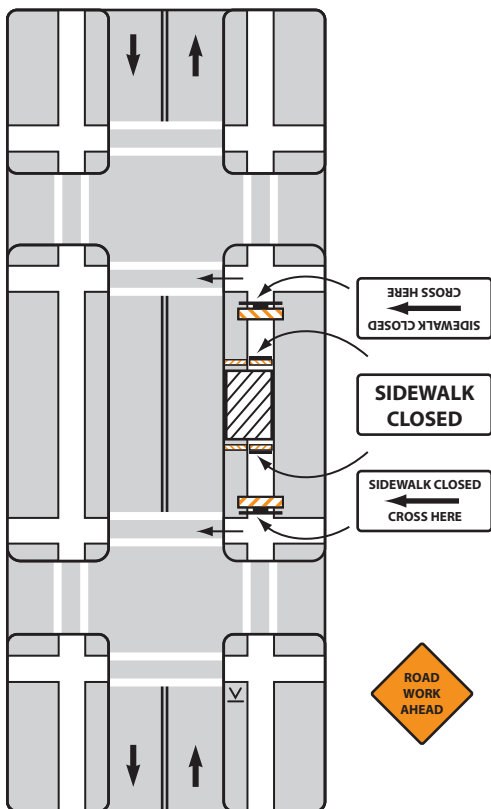

### Notes:

1. Where sidewalks exist, make provisions for persons with disabilities.
2. Only the traffic control devices controlling pedestrian flows are shown. Other devices may be needed to control traffic on the streets. Use lane closure signing as needed.
3. For nighttime closures, Type A flashing warning lights may be used on barricades that close walkways. Temporary street lighting may also be considered.

## Sidewalk Diversion (Pedestrian Bypass Provided)

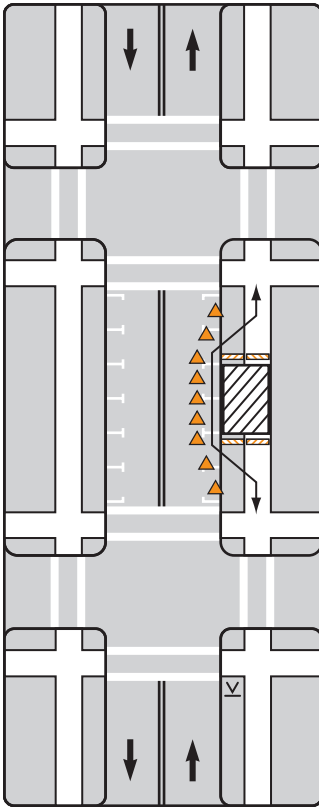

### Notes:

1. Where sidewalks exist, make provisions for persons with disabilities.
2. Only the traffic control devices controlling pedestrian flows are shown. Other devices may be needed to control traffic on the streets. Use lane closure signing as needed.
3. For nighttime closures, Type A flashing warning lights may be used on barricades that close walkways. Type C steady-burn lights may be used on channelizing devices separating the temporary walkway from vehicular traffic. Temporary street lighting may also be considered.
4. Where high speeds are present, install temporary longitudinal barriers to separate pedestrians from vehicular traffic. Refer to the SCDOT "Standard Specifications for Highway Construction" latest edition and Part 6 of the MUTCD for information on barriers.
5. Signs may be placed along a temporary walkway to guide or direct pedestrians. Examples include "Keep Right" and "Keep Left" signs.

## Flagging Procedures

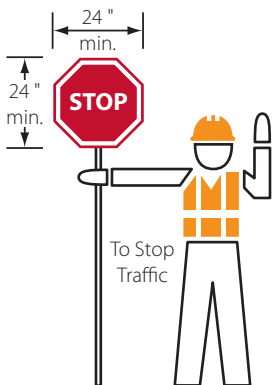

### Properly Trained Flaggers

- Provide clear messages to drivers as shown
- Allow distance for drivers to react
- Coordinate with other flaggers

### Properly Equipped Flaggers

- Approved sign paddles
- Approved safety vest and hat
- Approved safety vest and safety pants that comply with ANSI/ISEA 107-2004 standard performance for Class 3 risk exposure during nighttime flagging operations
- Retroreflective night equipment



### Proper Flagging Stations

- Good approach sight distance
- Highly visible to traffic
- Never stand in a moving traffic lane



### Proper Advance Warning

- Always use warning signs
- Allow reaction distance from signs
- Remove signs when not flagging

*Flags should only be used in emergency situations. Flags used for signaling shall be a minimum of 24" x 24", red in color, and mounted on a staff about 3' long.*

## *Liability*

### **Steps to Minimize Liability:**

- Have a current traffic control plan
- Follow the MUTCD (Manual on Uniform Traffic Control Devices)
- Minimize traffic disruptions
- Promptly remove devices
- Train all personnel
- Inspect work zone sites regularly for conformance

### **Elements of a Good Inspection Program:**

- Routine schedule
- Report form
- Hazard identification
- Adequate personnel and equipment inventory
- Repair verification
- Formal documentation

### **Minimum Documentation:**

- Starting and ending time of work
- Location of work
- Type, condition, and position of traffic control devices
- Names of personnel
- Type of equipment used
- Any change in temporary or permanent regulatory devices
- Additional information should be gathered in the event of an accident

### **Supervisor's Checklist**

1. Follow Part 6 of the MUTCD. It is the national standard for work zone traffic control.
2. State and local manuals that supplement the MUTCD may need to be used.
3. Have a plan before going to the work site.
4. Ask yourself, "What is the driver's view?"
5. Remove the devices in a timely manner.

## ***Important Notice***

This booklet is provided by the South Carolina Transportation Technology Transfer Service (T<sup>3</sup>S). To the best of our knowledge, the procedures shown in this booklet are consistent with SCDOT policies as of the date of publication of the booklet. This booklet has been reviewed by and approved by SCDOT.

SCDOT continually updates its policies and procedures regarding Work Zone Safety. As SCDOT notifies T<sup>3</sup>S of changes to the procedures in this booklet, T<sup>3</sup>S will post these changes at the T<sup>3</sup>S website, [www.clemson.edu/t3s](http://www.clemson.edu/t3s).

## ***Information***

Transportation Technology Transfer Service  
Clemson University  
Glenn Department of Civil Engineering  
125 Lowry Hall  
Clemson, SC 29634-0911  
Telephone: (888) 414-3069  
Email: [t3s@ces.clemson.edu](mailto:t3s@ces.clemson.edu)

To order this publication please call 888-414-3069 or email [t3s@ces.clemson.edu](mailto:t3s@ces.clemson.edu).

This publication also may be purchased over-the-counter at the T<sup>3</sup>S office.

T<sup>3</sup>S will accept check (make payable to Clemson University) and credit card. Payment must be received before items can be shipped.

